

RU

GB

INSTALLATION MANUAL  
SKID PLATE FOR ENGINE BAY AND TRANSMISSION CASE



**HONDA Stepwgn** 1,5 AT FWD

2015 - 

09.4638/09.4639

14/08/20

1/6



**(RU)** /  
**(GB)** Location/Position Arrow

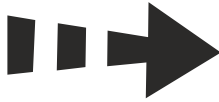

**(RU)**  
**(GB)** Movement Arrow



**(RU)**  
**(GB)** Screw Arrow

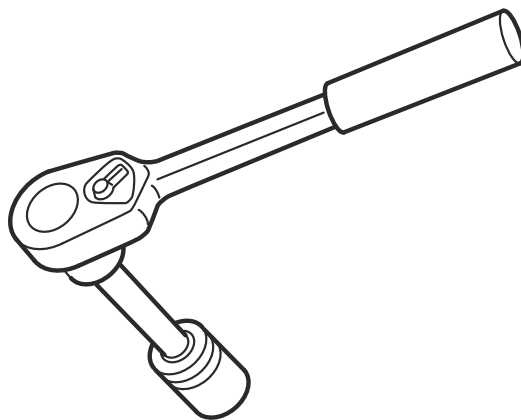
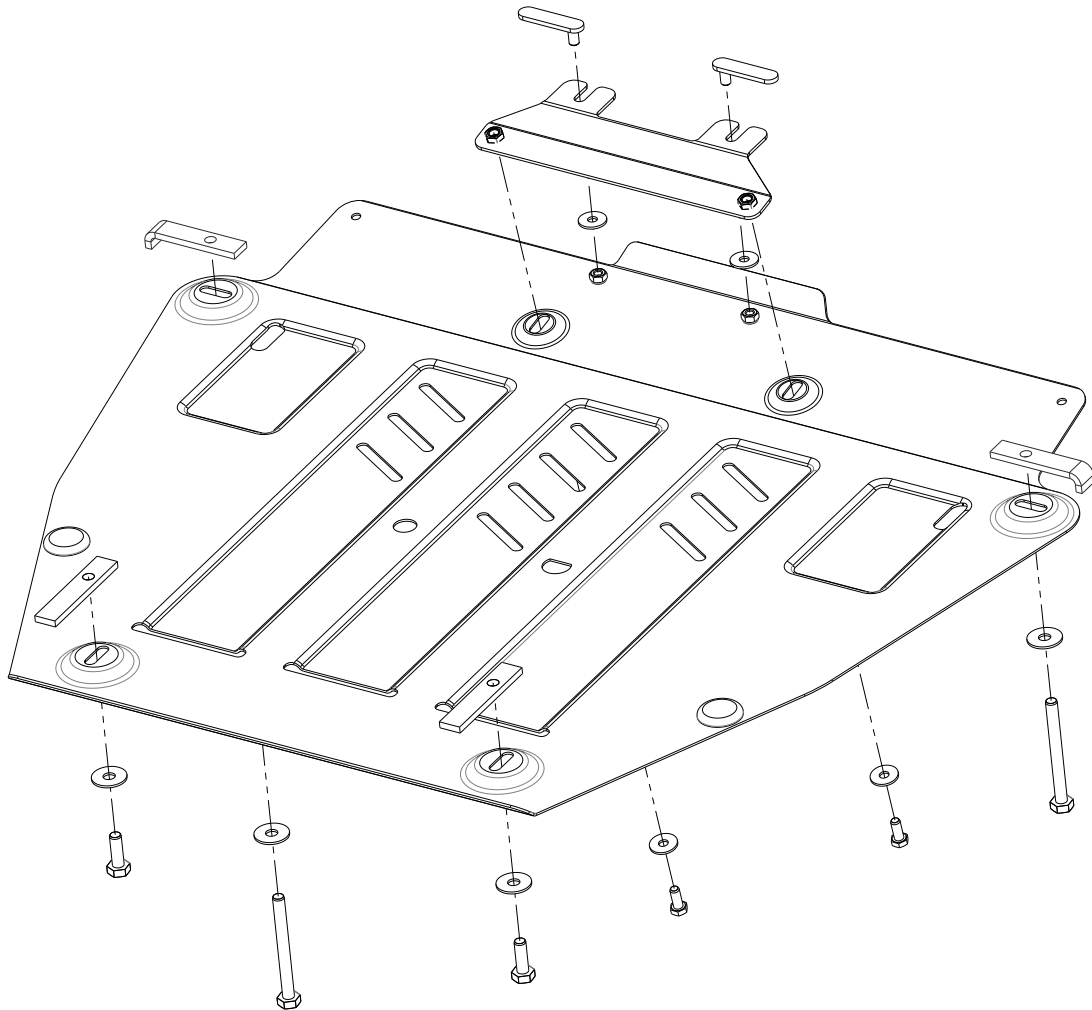

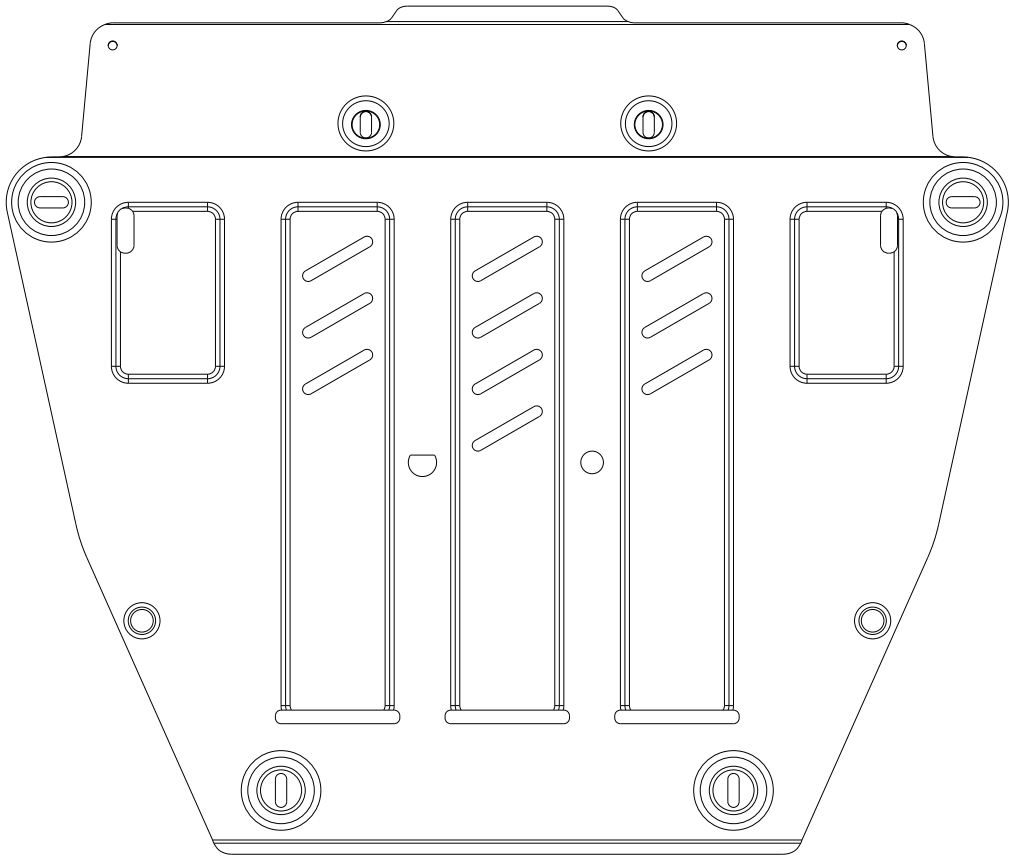
**A**

1X

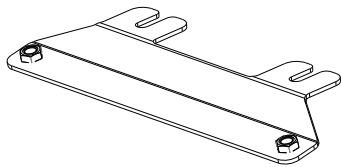
**B**

1X

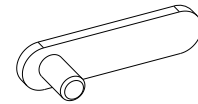

17003

2X

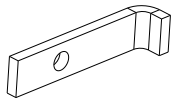
**D**

16001

2X

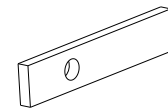
**E**

3004

2X

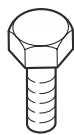
**F**

M10 100

2X

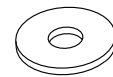
**G**

Ø8

4X

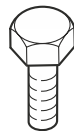
**H**

M8 20

2X

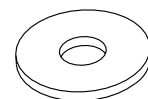
**I**

Ø10

4X

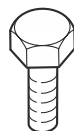
**J**

M10 30

2X

**K**

M8

2X



09.4638/09.4639

14/08/20

3/6

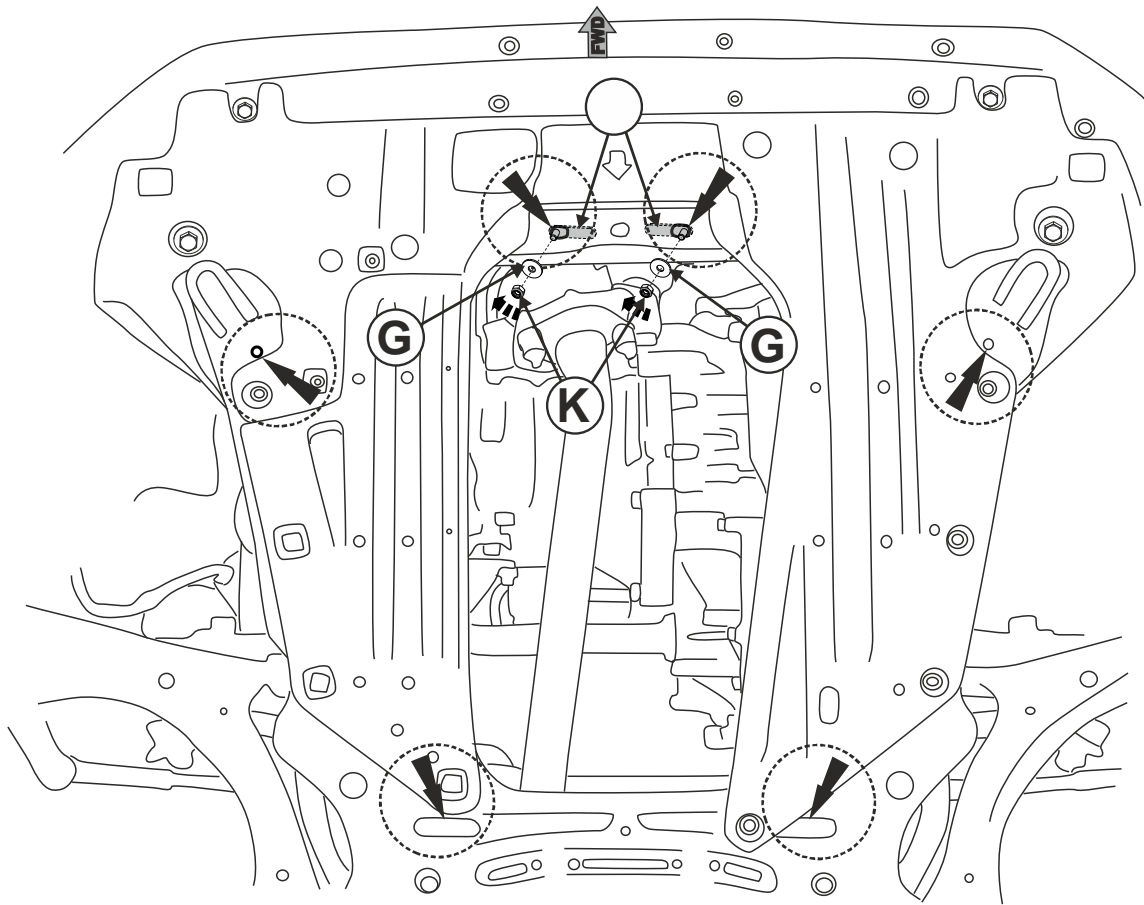

1

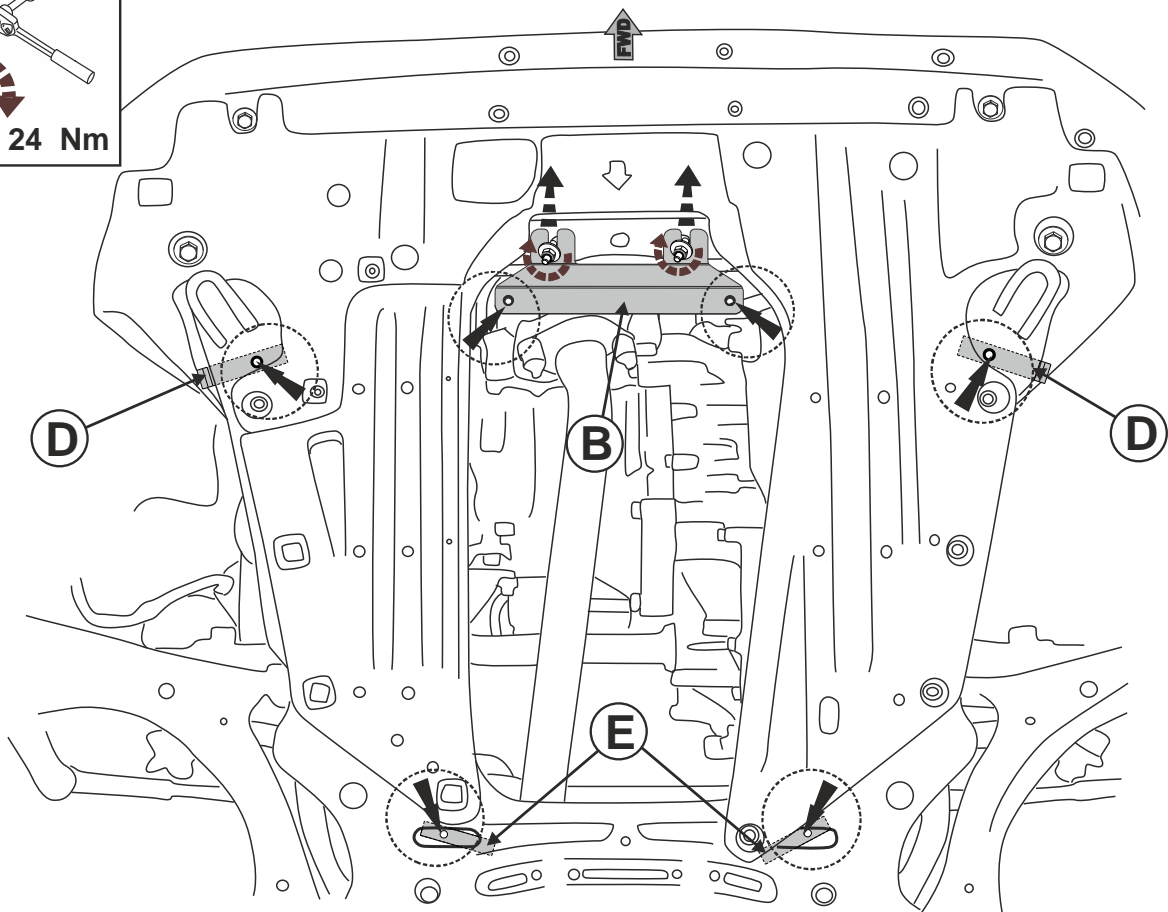
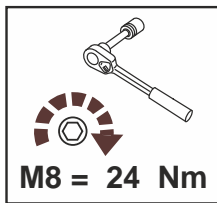

2

